

The proper rocker arm geometry and pushrod length is critical to obtain the maximum performance out of your engine. The ratio of the rocker arm can be altered (reduced) if the geometry is incorrect. This will reduce the area –under-the-curve and available breathing time thereby lowering the power output. The ratio of the rocker arm is affected by the position of the adjusting screw ball (or cup). The small block is the most sensitive to this adjustment, due to the angle of the pushrod.

These instructions are designed to help you find the proper dimensions for your particular combination and will require custom made pushrods which we can supply.

- 1. Install the rocker arms on the shafts and mount them in the saddles on the head. Check the rocker to retainer and spring clearance**

Note: Use a small diameter wire to check for rocker arm clearance at the spring and retainer. .020" is adequate. The clearances increase as the valve opens.

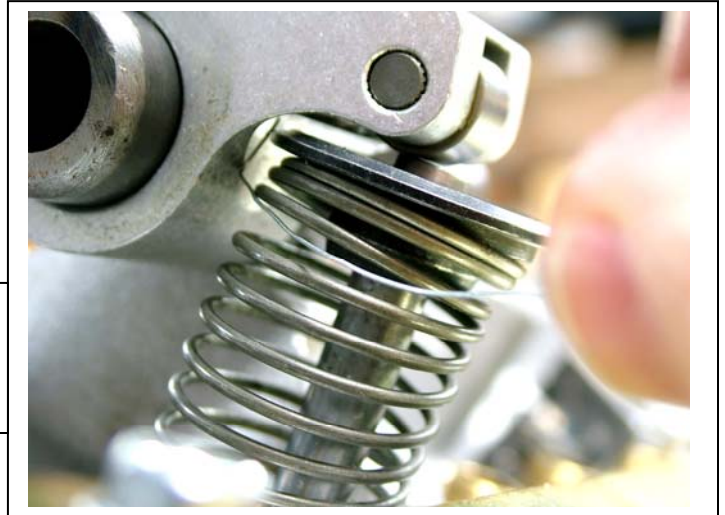

Saddle shims are provided to raise the rocker shafts if the rockers contact the retainers or springs (.010" - .020" clearance is adequate. If more than .080" of shims are required call us.) or, to move the roller wipe pattern toward the exhaust side of the valve. Check this wipe pattern at this time. The roller position with valve closed should start out in the position shown. Biased toward the intake side of the head. (see below)

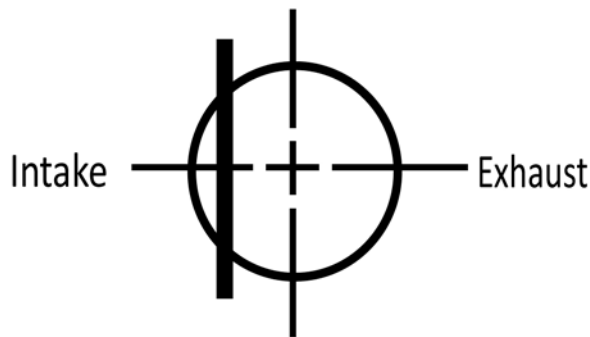

- 2. Install a dial indicator on the valve spring retainer**

Note: Install the dial indicator making sure the stem is parallel to the stem travel.

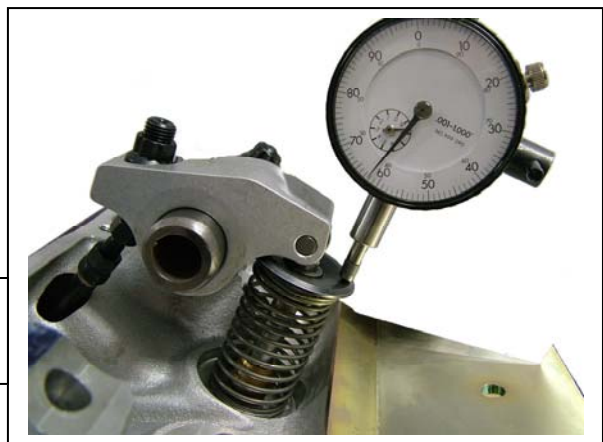

2 cont'd. You are going to adjust the pushrod length and the adjusting screw protrusion to obtain the highest possible valve lift. Thread the adjusting screw in the rocker so that the ball is protruding the correct amount from the rocker body.

Small Block LA approximately .450"

Small Block Magnum approximately .275"

Big Block approximately .300"

Note: Photo shows measuring for screw protrusion.



3. Install the rocker/shaft along with the adjustable pushrod.

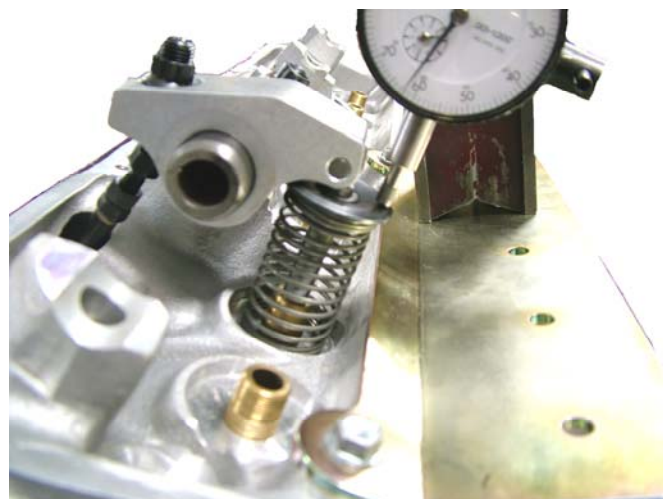

4. Rotate the crank/camshaft so the lifter is on the heel of the cam



Adjust the pushrod length to be snug against the adjuster screw ball but not so tight as to move the dial indicator more than .005/.010".

Note: Indicator should be .000" zeroed with enough travel left to allow the full lift to be indicated.

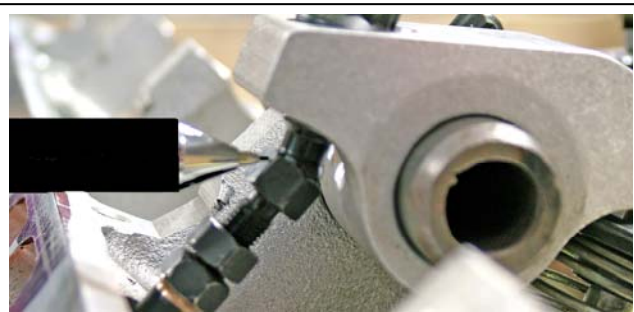

5. Rotate the crankshaft through one full lift cycle and note the total lift. It is .610" in this example.

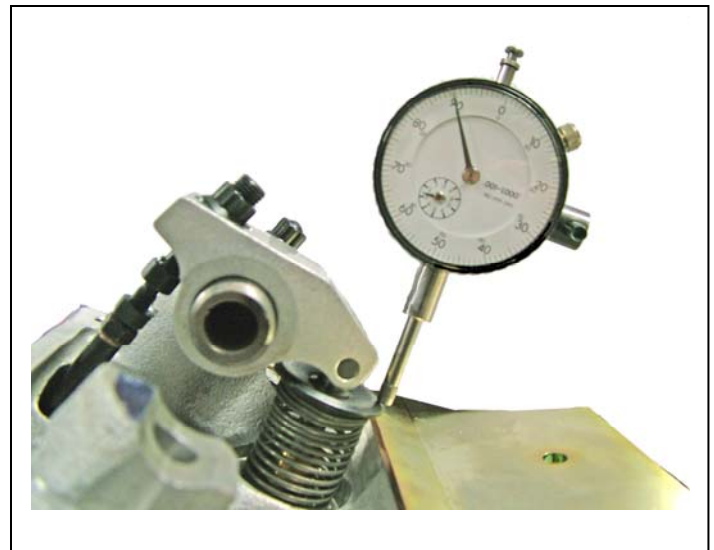

6. Next, loosen the pushrod and shorten it up ½ turn and change the adjusting screw position to take up the slack.

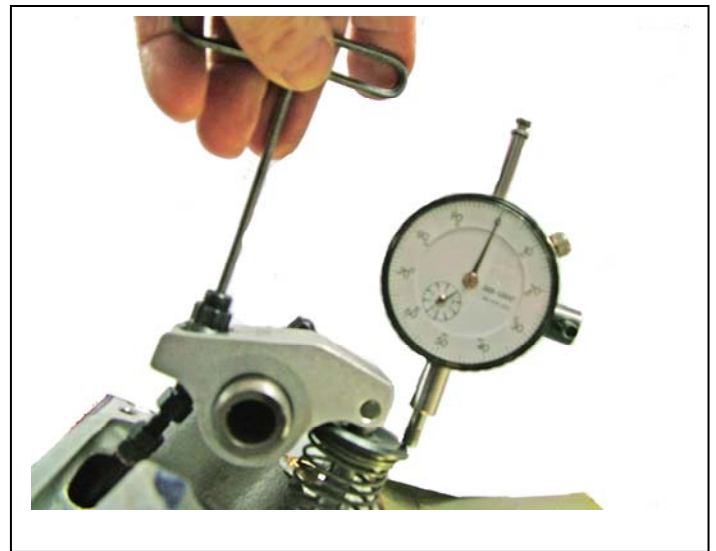

7. Check your dial indicator zero and rotate the crankshaft through one full lift cycle. Note the lift change.

In the example the lift has increase to .613" indicating better geometry. This shows that you are progressing in the correct direction. If you lost lift, you must make the pushrod longer and the adjusting screw shorter.

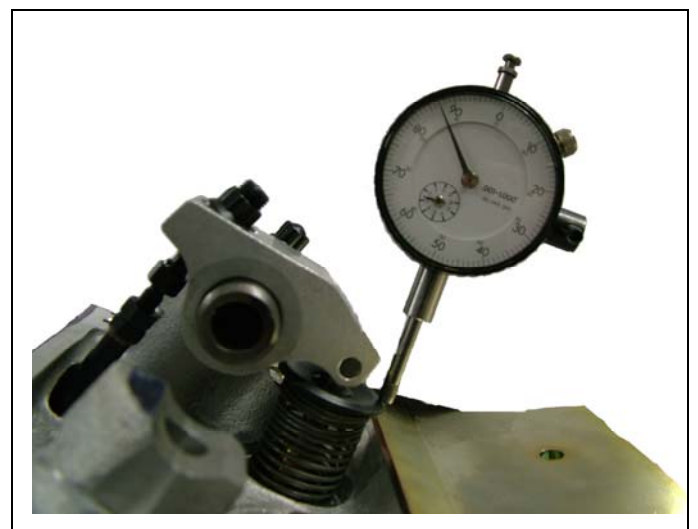

8. If the valve lift increased you are going the right direction. Continue to shorten the pushrod $\frac{1}{4}$ turn at a time, and take up the slack with the adjuster screw until you find the highest lift.
9. If you lost lift when you shortened the pushrod you must go back and lengthen the pushrod 1 turn. $\frac{1}{2}$ turn returns you to the starting length and $\frac{1}{2}$ turn more makes it longer. When lengthening the pushrod it will work best if you shorten the rocker adjusting screw first and then lengthen the pushrod to take up the slack.

10. Once you have achieved the maximum lift, you have the correct geometry and pushrod length.
Note: At this point, if you are using a mechanical (solid) lifter camshaft, shorten the pushrod to establish the lash. This will give you the best pushrod length.

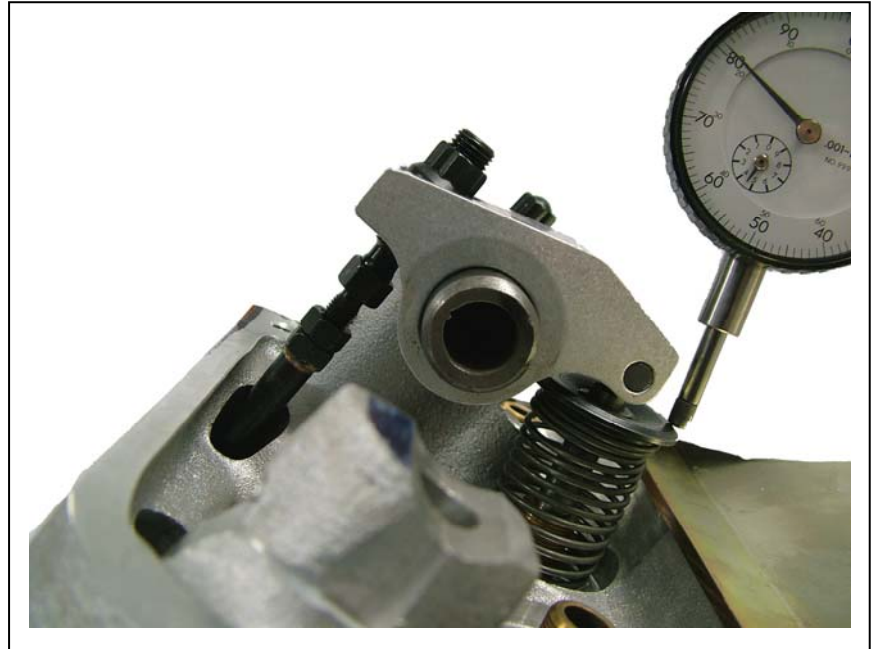

11. If you find you must raise the rocker shaft, use the included #1710 special, aluminum, shims to correct the problem. These shims do not crush the rocker shaft like the more common flat steel shims do and seal the oil better than steel shims. Shims are in thicknesses of .020", and .040" and can be stacked.
NOTE: Most cases require stacking shims. Oil the shims individually and tighten them into place to contour them before final installation and torquing. When stacking 3 or more shims special trimming instructions are provided with the shims.
12. Once the pushrod length is determined the rocker tip to valve stem alignment should be checked. The rocker arm tip travel should be located as close as possible to the center of the valve stem tip when viewed from the top and side of cylinder head. (See Illustration #2, below). The rocker arms may contact the retainer/spring if they are not properly centered side to side. In some cases the rocker/roller can be offset to the extreme position for pushrod clearance.(Illustration #1, below)

13. The rocker arm tip/roller wipe should be checked across the center of the valve stem tip when the valve is lifted through its entire travel. This wipe pattern is most easily determined by “painting” the top of the valve stem with a felt tip marker and turning the engine over a few revolutions. This will leave a mark in the ink showing the wipe pattern (See Illustration #2, below). If you find the wipe pattern is not centered as shown but the pattern is no closer to the edge than .040” it is acceptable. Hughes Engines Inc. can machine your rocker shaft saddles to correct this situation—it is common on small block LA iron heads or with Crane or foreign rockers.

14. On all heads, check for pushrod-to-tunnel interference, and correct as required. Some race heads may need considerable clearancing. Check before final assembly. .002” is enough at tightest point during lift.

Note: Pushrods can touch on their sides without problems as long as they don't rub hard enough to tear a piece of masking tape off of the pushrod, run them!

15. Now you have the correct pushrod length and valve train geometry. Return the Checking pushrod/lifter to us and we will cut and assemble a set of pushrods specifically for your engine.

16. As you can see, there are several points to check when correctly installing adjustable or roller tip rockers and measuring for proper pushrod length. Sometimes, all of the desired settings cannot be reached. The first and most important point to check and correct is interference problems. Second is obtaining the maximum valve lift. Third is the tip-to-valve alignment and “wipe” area.

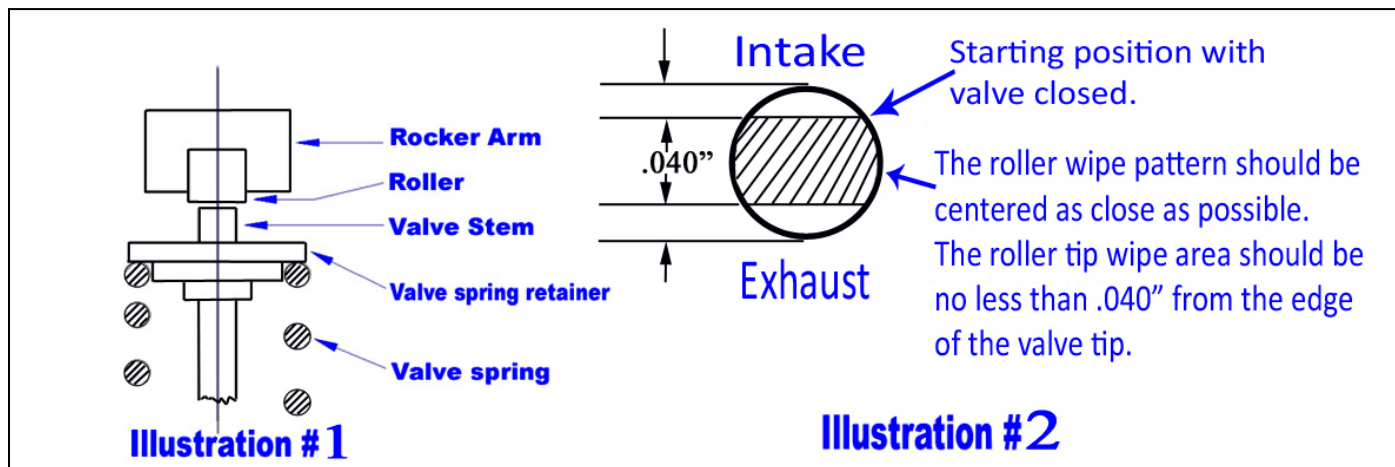

Helpful tips

1. Always make sure your dial indicator is perfectly aligned with the valve stem or you won't show accurate lift numbers. A little angle change will make quite a difference.
2. Make sure your pushrod locking nut and rocker nut are snug during your tests. The normal rotation of the lifter can cause the screws to lengthen or shorten.
3. Always make sure your dial indicator is zeroed before each lift check.
4. As you approach the best pushrod length/rocker geometry position you must make your changes shorter in length or you will overshoot your goal.
5. This procedure is the most important when working on a small block due to the angle between the lifter and the pushrod. The pushrod length and rocker screw position will change depending on the lifter type/length. The functioning length of the hydraulic roller lifter is approximately 9/16" longer than the solid flat tappet style lifter.